



POLARIS

GIANT FOUNTAIN

- » 4 year all-inclusive warranty, or 5 year warranty when purchased with Sub-Monitor controls.
- » Operates in 40in or 1m of water.
- » Complete package includes assembled unit, power control center, and cable. (No PCC for 50Hz)
- » Fiberglass power control center comes standard with surge arrestor, timer and GFCI. (Exception: Optional EPD for 460V)
- » Cable quick disconnect. (Standard for 50Hz)
- » Wheeled launching system ends the need for hoists and cranes in most applications.
- » Removable screen protects pump from debris, and is easy to clean from the water.
- » Safety tested and listed with ETL, and ETL-C, conforming to UL standards; and carries a CE certification.
- » Optional accessories include Fountain Glo™ 250W, 500W or 1000W light systems; wind controls, and power monitoring Sub-Monitor.

50 HZ	10 HP	15 HP	25 HP
Spray Height (m)	7	8.5	10.1
Spray Diam. (m)	2.4	2.4	2.4
m ³ /hr	153.2	170.3	272.4
Volt/Ph/Amp 2875@50hz	400/3/16	400/3/24	400/3/40

Product specifications and CADs can be found online through www.otterbine.com or www.caddetails.com.

www.otterbine.com/polaris



Manufactured by: Otterbine® Barebo, Inc. | 3840 Main Road East | Emmaus, PA 18049 U.S.A | PH: 610-965-6018 | Email: info@otterbine.com

PRODUCT ILLUSTRATION

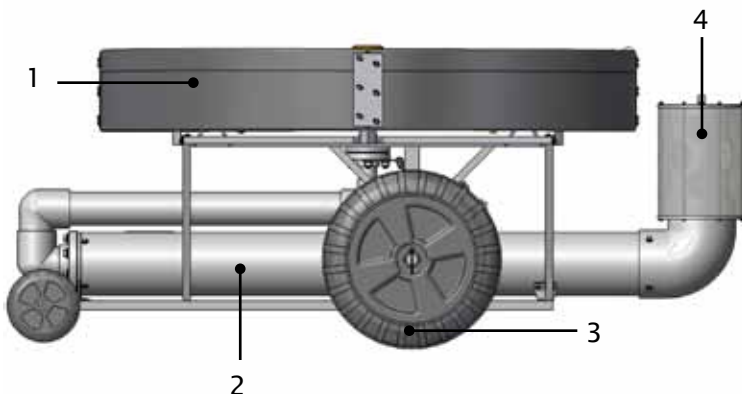

1. Special polyethylene float allows for easy height adjustment to make it less visible in the water.
2. High quality Grundfos pump and Franklin 3450/2875 RPM motor ensure years of corrosion-resistant, trouble-free run time and no maintenance.
3. Large center wheels assist installation and removal eliminating the need for a crane in most applications.
4. Removable stainless steel intake screen allows for cleaning in the water and protects pump from debris.

Dimensions: 10HP & 15HP = 100in (254cm) x 74in (188cm) x 40in (102cm); 25HP: 120in (305cm) x 90in (229cm) x 40in (102cm) Minimum operating depth is 40in or 1m, with and without lights. See www.otterbine.com for package details.